

About Samsung Medison CO., LTD.

Samsung Medison, an affiliate of Samsung Electronics, is a global medical company founded in 1985. With a mission to bring health and well-being to people's lives, the company manufactures diagnostic ultrasound systems around the world across various medical fields. Samsung Medison has commercialized the Live 3D technology in 2001 and since being part of Samsung Electronics in 2011, it is integrating IT, image processing, semiconductor and communication technologies into ultrasound devices for efficient and confident diagnosis.

\* This product, features, options and transducers are not commercially available in all countries.

\* Due to regulatory reasons their future availability cannot be guaranteed. Please contact your local sales network for further details.

\* This product is a medical device, please read the user manual carefully before use.

\* S-Vue Transducer™ is the name of Samsung's advanced transducer technology.

1. Optional feature which may require additional purchase.

2. SonoSync™ is an image sharing solution.



Scan code or visit  
[www.samsunghealthcare.com](http://www.samsunghealthcare.com)  
to learn more

**SAMSUNG MEDISON CO., LTD.**

© 2021 Samsung Medison All Rights Reserved.

Samsung Medison reserves the right to modify the design, packaging, specifications, and features shown herein, without prior notice or obligation.

Life-long Healthcare Solutions  
for Women

**SAMSUNG**

CT-HERA W10 V1.02-EDA-210419-EN

New momentum of imaging

# HERA W10



CE0123

## New momentum of imaging

HERA, an acronym stands for Hyper-aperture and Enhanced Reconstruction Architecture, is Samsung's new preeminent ultrasound platform committed to deliver astonishing images. Likewise, HERA platform offers access to the state-of-the-art ergonomics with simple yet ingenious look for the satisfaction in medical care.

HERA W10, the premier model of the HERA platform, will help you get more insight in diagnosis with its intuitive visualizations, precise analytic features, and instant operation. It is our commitment for Obstetrics and Gynecology applications to support for life-long healthcare of women, diligently pursuing for new possibilities in ultrasound diagnosis.

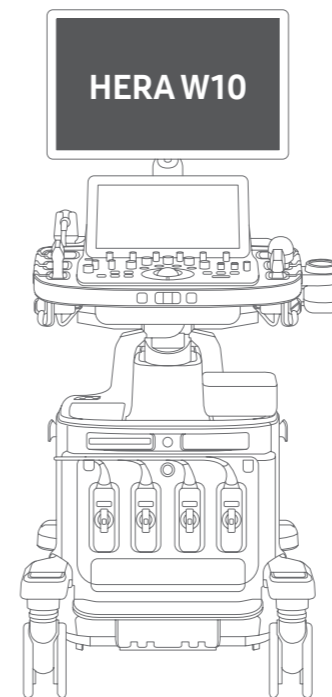

## Redefined imaging technologies powered by Crystal Architecture™

Crystal Architecture™, an imaging architecture that combines CrystalBeam™ and CrystalLive™, based upon S-Vue Transducer™, is to provide crystal clear image. CrystalBeam™ is a new beamforming technology beneficial in delivering high-quality image resolution and increased uniformity of images.

CrystalLive™ is Samsung's up-to-date ultrasound imaging engine with enhanced 2D image processing, 3D rendering and color signal processing, to offer outstanding image performance and efficient workflow during complex cases.



**Fast Frame Rates**  
X10 Data Transfer Rate \*



**High-Quality Images**  
X11 Processing Power \*



**Fast Rendering**  
X3 GPU Memory \*

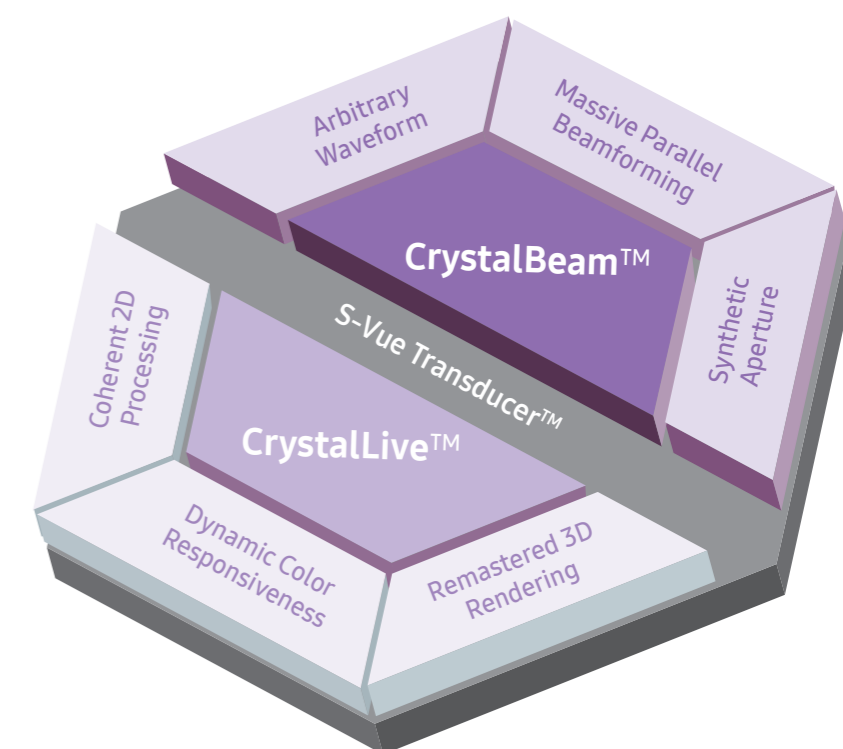

**Crystal Architecture™**

\* Compared to the Samsung WS80A

## A new beamforming for in-depth image creation

CrystalBeam™ utilizes Arbitrary Waveform Transmission, Massive Parallel Beamforming, and Synthetic Aperture technologies to produce a faster frame rate and improved image uniformity. Arbitrary Waveform Transmit refers to a widely-focused beam transmission technology that allows for more coherent images; sequentially Massive Parallel Beamforming and Synthetic Aperture enable more enriched and faster beam processing, based on a large amount of acquired ultrasound data.

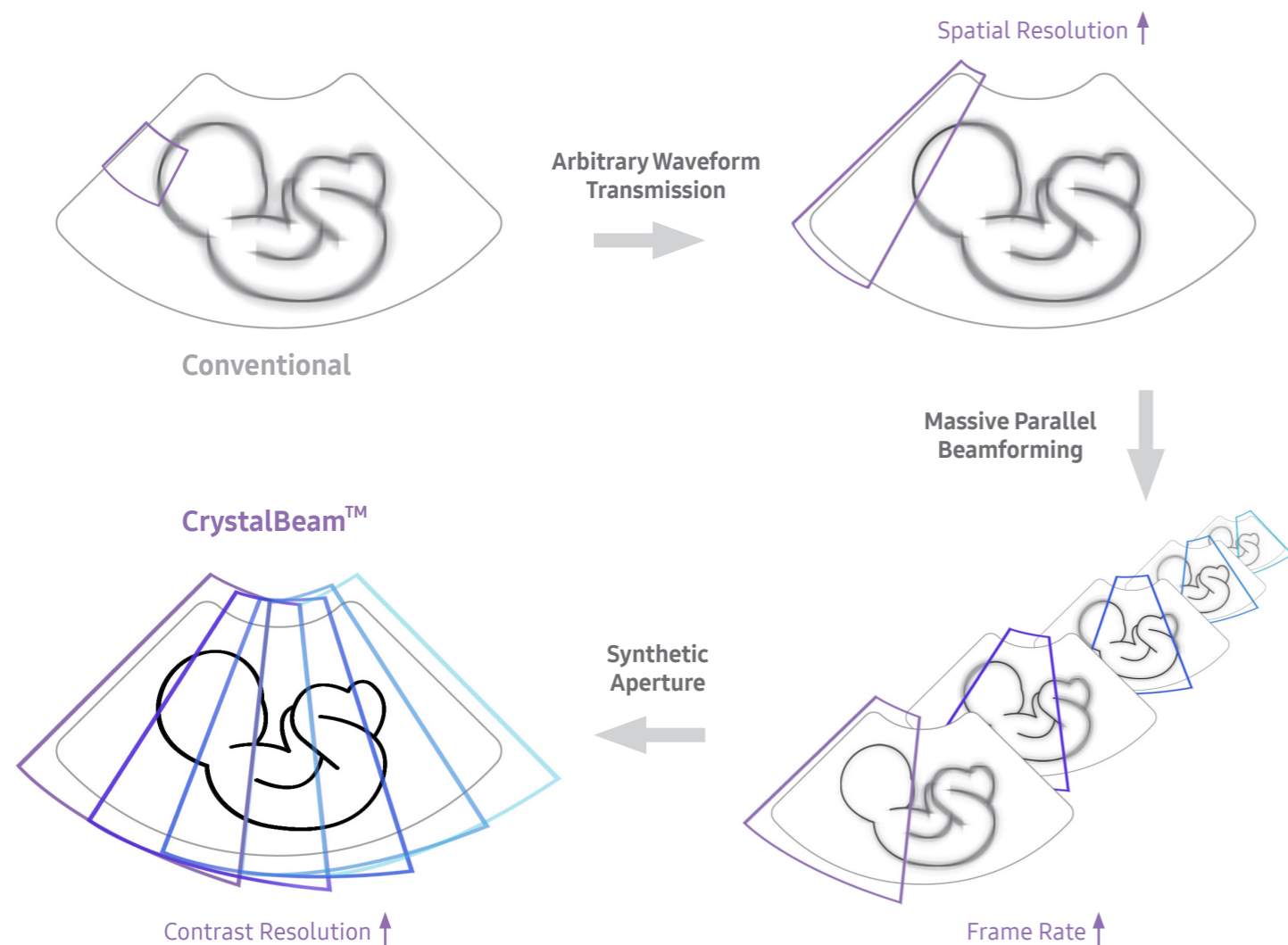

\* Compared to the Samsung WS80A

## Sophisticated 2D images processed by CrystalLive™

CrystalLive™ helps you to make more confident diagnoses with fundamental 2D images. Some major advantages of 2D images include shadow-suppressed images, lessened halo artifacts, and mitigated blurred area. ShadowHDR™ is a key feature that shows shadowy areas, making it especially applicable for use in highly attenuated regions, such as fetal head or spine.



### Visualization of attenuated shadow area

ShadowHDR™ selectively applies high-frequency and low-frequency of the ultrasound to identify shadowy areas such as fetal head or spine where attenuation occurs.

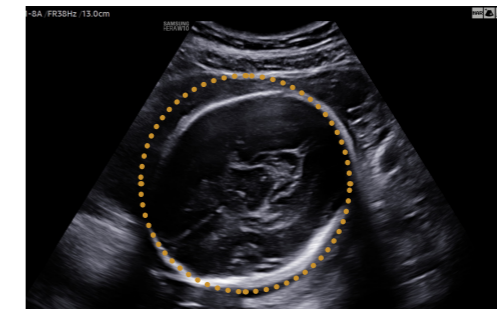

Fetal brain

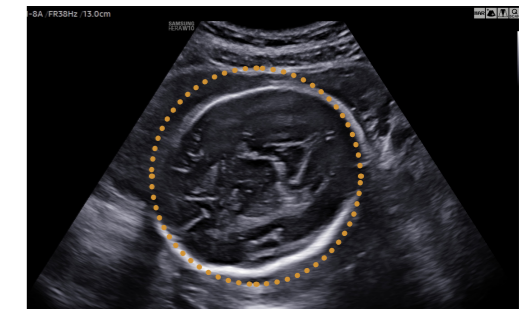

Fetal brain with ShadowHDR™



### Improvement of 2D image quality with noise reduction filter

ClearVision provides clear tissue boundaries using the noise reduction filter and generates sharp 2D images. It reduces halo artifact that occurs when the tissue contour is enhanced, and removes noises on the tissue boundaries.

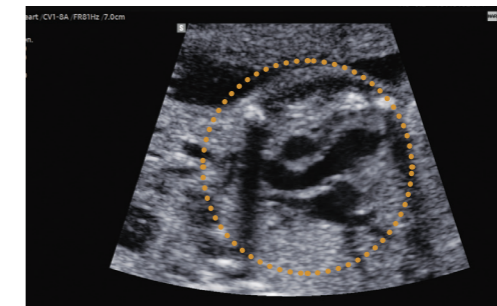

Fetal heart

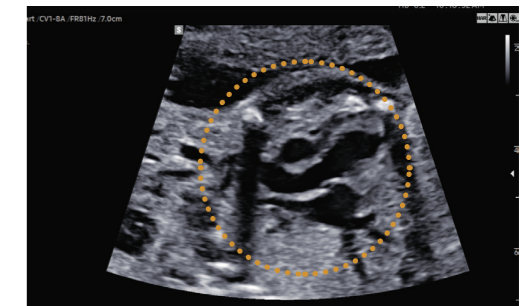

Fetal heart with ClearVision



### Clarification of blurred area to provide clearer images

HQ-Vision™ provides clearer images by mitigating the characteristics of ultrasound images that are slightly blurred than the actual vision.

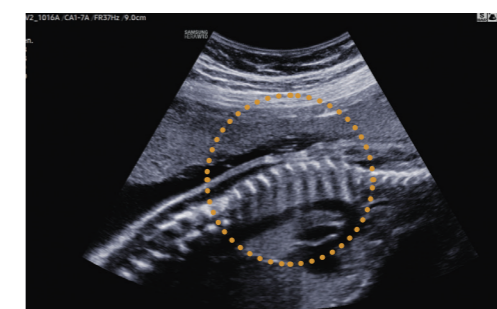

Fetal spine

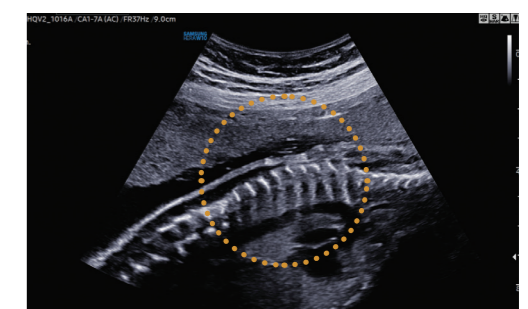

Fetal spine with HQ-Vision™

## Realistic description of 3D/4D performance

CrystalLive™ in 3D/4D provides users with more realistic and high-resolution images. It outdoes conventional 3D imaging technologies in terms of viewing small parts and lighting effects. In addition, you are able to see 3D anatomy with more realistic depth perception, and can visualize the internal and external structures at once.



### High Definition Volume Imaging

HDVI™ is a volume rendering technology that improves visualization of edges and small structures in volume data. Upgraded marginal expression and image saturation expresses the very details from angle to shadow of the fetus.



Fetal face with 3D



Fetal spine with 3D



### Realistic expression of 3D anatomy<sup>1</sup>

RealisticVue™ displays high resolution 3D anatomy with exceptional detail and realistic depth perception. User selectable light source direction creates intricately graduated shadows for better defined anatomical structures.



Fetal face with RealisticVue™



Early fetus with RealisticVue™

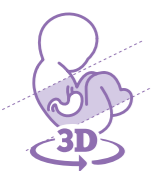

### Visualization of internal and external structures with volume rendering<sup>1</sup>

CrystalVue™ is an advanced volume rendering technology that enhances visualization of both internal and external structures in a single rendered image using a combination of intensity, gradient and position.

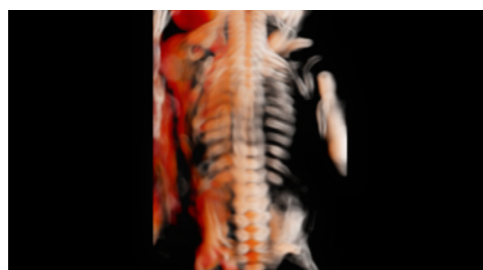

Fetal spine with CrystalVue™

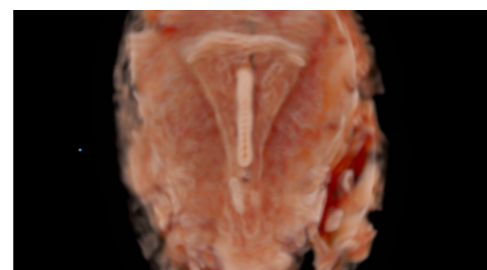

Intra uterine device with CrystalVue™

## Detailed expression of blood flow dynamics

Color performance of CrystalLive™ has been improved to clearly visualize the hemodynamics of the blood flow. Greater sensitivity resulting from new color signal processing allows for a more accurate detection of peripheral blood vessels, microcirculatory blood flows, and volumes of slow blood flows.



### Directional power Doppler to examine peripheral vessels

S-Flow™, a directional Power Doppler imaging technology, can help to detect even the peripheral blood vessels. It enables accurate diagnosis when the blood flow examination is especially difficult.



Umbilical cord with S-Flow™



Fetal circulation with S-Flow™



### Visualization of slow flow microvascularized structures<sup>1</sup>

MV-Flow™ offers a novel alternative to power Doppler for visualizing slow flow of microvascularized structures. High frame rates and advanced filtering enable MV-Flow™ to provide a detailed view of blood flow in relation to surrounding tissue or pathology with enhanced spatial resolution.



Placenta with MV-Flow™

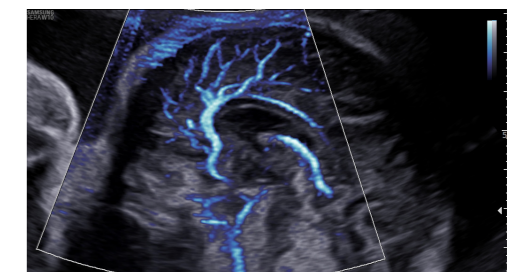

Pericallosal Artery with MV-Flow™



### Three dimensional-like visualization of blood flow

LumiFlow™ is a three-dimensional visualization of blood flow, which helps to understand the structure of blood flow and small vessels intuitively.

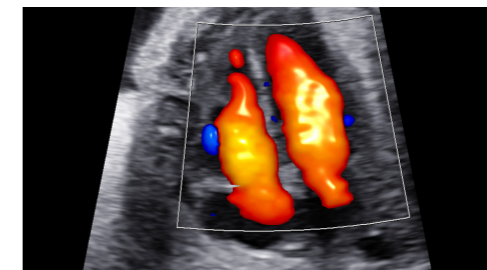

Color Doppler with LumiFlow™ (4 Chamber view)

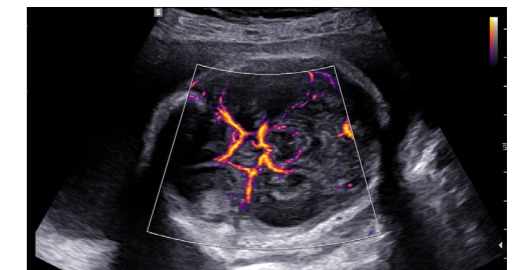

MV-Flow™ with LumiFlow™ (Circle of willis)

# Enriched diagnostic system, excellence in utilization

Images created by the Crystal Architecture™ technologies enhance various diagnostic features of Samsung ultrasound. HERA W10's diverse technologies to examine the growth of fetus and women's health in detailed reports will help you build more confidence and enhance the workflow in your diagnosis.

## HeartAssist™ 1

A semi-automated reporting tool for fetal heart diagnosis

HeartAssist™, while based on big data, it semi-automatically classifies ultrasound image into measurement views required for fetal heart diagnosis and provides measurement results and distribution graph.

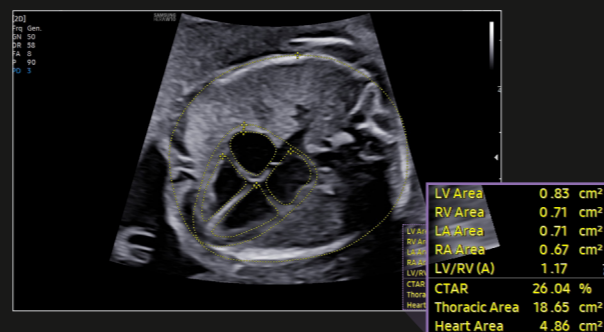

HeartAssist™

## ViewAssist™ 1

A semi-automated classification of the images and annotation of the structures

ViewAssist™ provides automatic classification of the ultrasound images and annotation of the structures to help healthcare professionals in convenient measurement.

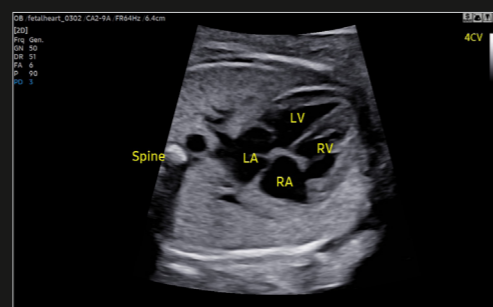

ViewAssist™

## Uterine Contour

A feature to extract the centerline and thickness of endometrium

Uterine Contour semi-automatically extracts the centerline and thickness of the curved endometrium and provides a coronal view in 3D, flattened by the centerline. In addition, uterine malformation classification are reported according to the \*ESHRE/ESGE or ASRM guideline selection.

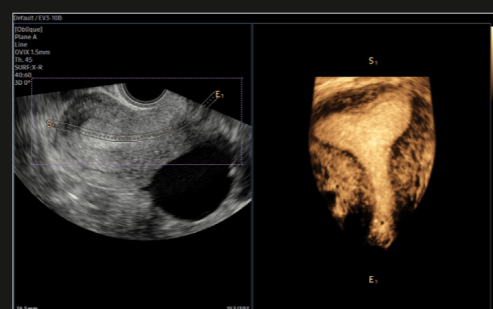

Uterine Contour

\* ESHRE/ESGE : The European Society of Human Reproduction and Embryology / The European Society for Gynaecological Endoscopy  
ASRM : The American Society for Reproductive Medicine

## BiometryAssist™

A semi-automated measurement of fetal biometry

A semi-automatic technology for biometric measurement, BiometryAssist™, enables users to measure the growth of the fetus quickly while maintaining exam consistency.



Fetal biometry measurement with BiometryAssist™

## Slice A 1

A feature to increase the contrast resolution through thick slice volume

Slice A is a feature that improves the contrast resolution of A Plane images. By compositing multiple A Plane images, it helps in analyzing tissues or structures that are difficult to see with only 2D images.

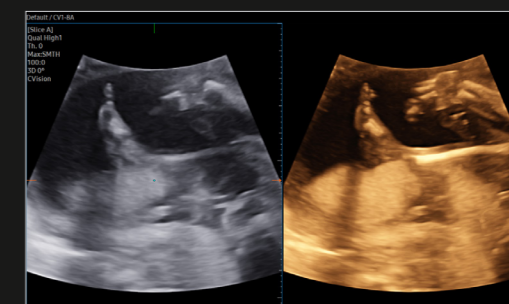

Slice A

## 5D CNS+™ 1 (Central Nervous System)

Fast brain measurement tool based on volume data

5D CNS+™ uses intelligent navigation to provide 6 measurements from 3 transverse views of the fetal brain to enhance measurement reproducibility and streamlined workflow.

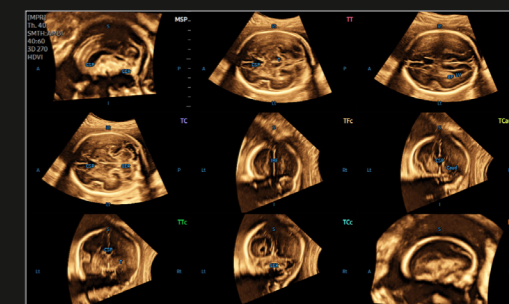

Fetal brain measurement with 5D CNS+™

## 5D Limb Vol.™ 1

Fast fetal weight estimation tool for checking growth of the fetus

5D Limb Vol.™ is a semi-automated tool to quickly and accurately measure upper arm or thigh volumes from 3 simple seed points on a single volume data set.

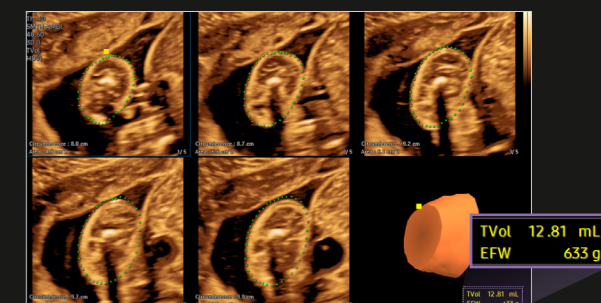

Fetal weight estimation with 5D Limb Vol.™

## MPI+ 1 (Myocardial Performance Index)

A semi-automated measurement of LV MPI and RV MPI

MPI+ is able to semi-automatically measure LV MPI and RV MPI, providing a high reproducibility. After acquiring Inflow/Outflow doppler, RV MPI proceeds alignment by utilizing synchronized signals of the heartrate and valve movement.

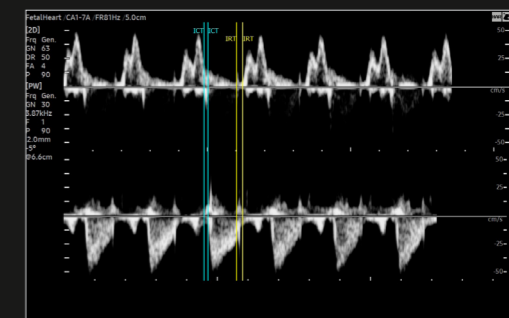

MPI+

# State-of-the-art ergonomics for your comfort and productivity

FreeForm™ refers to Samsung's new design theme. It was developed to provide a more comfortable diagnostic experience by reducing the need for movement from one spot to another. Our goal is to satisfy user's working environment by applying a mechanism to the control panel in its wide-moving range, as well as by considering a user's arm reach. This enables it to offer a sufficient amount of space for the user's knee.

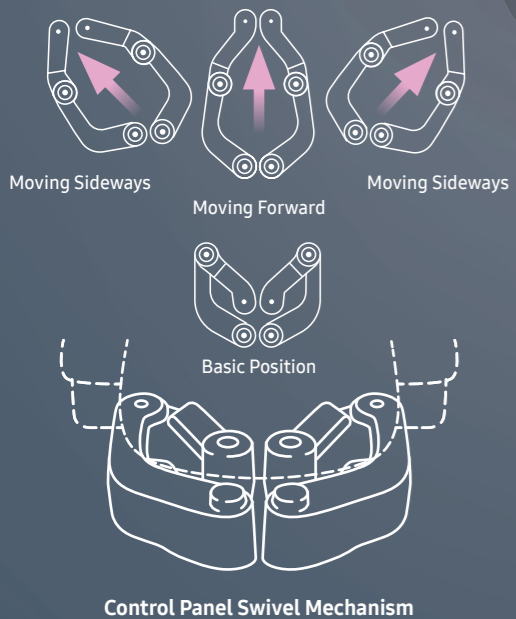
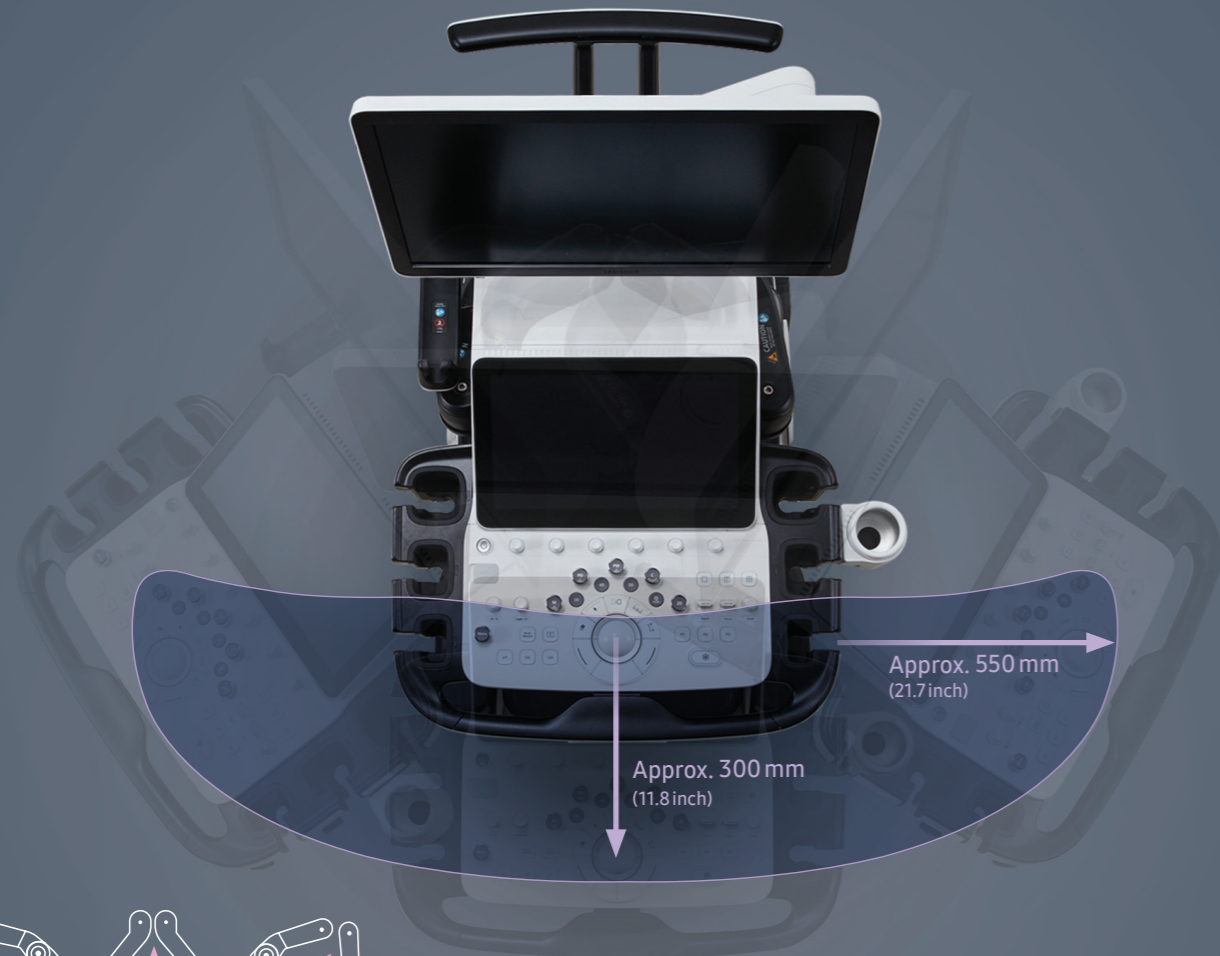

## Control Panel Moving Mechanism

An internal study showed that Samsung's Control Panel Moving Mechanism reduces shoulder stress by about a third compared to the previous model. It does this by providing users with more space near the control panel area, resulting in less repetitive strain from hours of scanning. Users can now pull the control panel and rotate its angle at the same time.

\* Control panel usability study compared to the Samsung WS80A. Tested using same body postures.



Winner of an IDEA SILVER AWARD 2018

The unique design of the HERA W10 communicates trust and confidence to both the user and the patient. The striking contrast of dark and bright, conventional and ergonomic improvements provides an iconic look for a preminent ultrasound system.



Endocavity Transducer Holder<sup>1</sup>



Cable Management



Mood Light

# Effective real-time collaboration, customizable for the way you work

We believe that a truly great system offers customer-centric working conditions. The collaborative solution enables users to cooperate, monitor, and educate in real-time regardless of where the users are located. The streamlined workflow supports your daily procedures by reducing keystrokes and by combining multiple actions into one. Users have the option of customizing its diagnostic settings based on personalized protocol, resulting in a more simplified exam process and faster workflow.

## SonoSync™<sup>1,2</sup> Real-time image sharing solution

SonoSync™ is a real-time image sharing solution that allows collaborative communication for care guide and training between doctors and sonographers. In addition, voice chatting and real-time marking function are provided for efficient communication, and the MultiVue function is included to monitor multiple ultrasound images on a single screen.



## HelloMom™<sup>1</sup> Simple transfer of fetal ultrasound images and clips

HelloMom™ is a simple and secure image sharing solution by generating QR code for the selected fetal images. Pregnant women and family are capable of downloading images of fetus by scanning on the QR code using smartphone, reducing the hassle of installing a separate application.

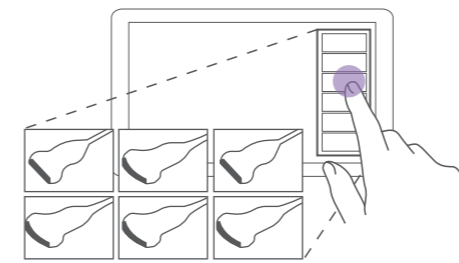

## QuickPreset for easy transducer preset

With one touch, the user can select the most common transducer and preset combinations. QuickPreset increases efficiency to make a full day of scanning simple and easy.

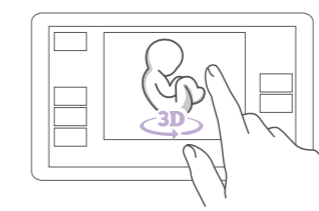

## Touch Gesture for your preferences

Touch Gesture intuitively allows to rotate, zoom and move while viewing the 3D image from the touch screen. In addition, 3D manipulations such as Oblique, MagiCut, etc. are conveniently operated.

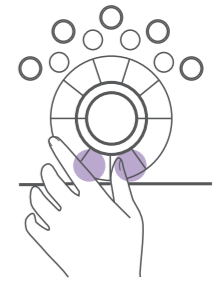

## Contextual Button for your convenient access

Depending on the user's choice of ultrasonic inspection items, the required diagnostic functions may be assigned to the control panel buttons to reduce the hassle of menu selection.



# Fast boot up with MobileSleep<sup>1</sup>

Booting-up from sleep mode saves about 63% of your time, when compared to a normal boot-up. MobileSleep enters to the sleep mode quickly for easy maneuverability of the system.



# Comprehensive selection of transducers

## Volume Transducers



**CV1-8A**  
Abdomen, obstetrics, gynecology



**EV2-10A**  
Obstetrics, gynecology, urology



**EV3-10B**  
Obstetrics, gynecology, urology

## Convex Array Transducers



**CA1-7A**  
Abdomen, obstetrics, gynecology, pediatric, vascular, musculoskeletal



**CA3-10A**  
Abdomen, obstetrics, gynecology, pediatric, vascular, musculoskeletal



**CA2-9A**  
Abdomen, obstetrics, gynecology



**CF4-9**  
Pediatric, vascular

## Linear Array Transducers



**LA2-14A**  
Small parts, vascular, musculoskeletal, abdomen, obstetrics



**L3-12A**  
Small parts, vascular, musculoskeletal, abdomen



**LA2-9A**  
Small parts, vascular, musculoskeletal, abdomen

## Endocavity Transducers



**EA2-11AR\***  
Obstetrics, gynecology, urology



**EA2-11AV\***  
Obstetrics, gynecology, urology

## Phased Array Transducers

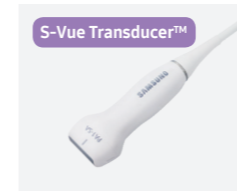

**PA1-5A**  
Cardiac, TCD, abdomen



**PA4-12B**  
Cardiac, pediatric



**PM1-6A**  
Cardiac, TCD, abdomen



**PA3-8B**  
Cardiac, pediatric, abdomen

### \* Ergonomic Transducer (EA2-11AR, EA2-11AV)

The new endocavity transducer supports natural grip by moving the max width point to a more forward position and also increased the length of the grip to allow balanced weight distribution.

## Secure your care Samsung Healthcare Cybersecurity

### Bringing peace of mind to your hospital and patients

To address the emerging need for cybersecurity, Samsung provides a solution to support our customers by offering the tools to protect against cyberthreats that may compromise invaluable patient data and ultimately degrade the quality of care. Samsung's Cybersecurity Solution strives to abide by the CIA triad (Confidentiality, Integrity, and Availability) and takes a comprehensive approach to providing impeccable protection with the following pillars: Intrusion prevention, Access control, and Data protection



### Intrusion prevention

Tools for protecting against cyber threats from external attacks

- Security tools (Anti-virus & Firewall)
- Secured operating system



### Access control

Strengthened surveillance for tracking the access of patient information

- Account management
- Enhanced audit trail



### Data protection

Encryption functions for safeguarding data whether at-rest or in-transit

- Data encryption
- Transmission security